

**UNITED STATES DISTRICT COURT
NORTHERN DISTRICT OF ILLINOIS, EASTERN DIVISION**

KATHY BEVERLY, an individual,
Plaintiff,

v.

NUWAVE, LLC, an Illinois Limited Liability
Company,

Defendant.

No. 1:19-cv-6707

PLAINTIFF DEMANDS TRIAL BY JURY

COMPLAINT

Plaintiff, **KATHY BEVERLY** (hereafter referred to as “Plaintiff”), by and through her undersigned counsel, **JOHNSON BECKER, PLLC** and **TOMASIK, KOTIN & KASSERMAN, LLC**, hereby submits the following Complaint and Demand for Jury Trial against Defendant **NUWAVE, LLC** (hereafter referred to as “Defendant NuWave”), and alleges the following upon personal knowledge and belief, and investigation of counsel:

NATURE OF THE CASE

1. Defendant NuWave designs, manufactures, markets, imports, distributes and sells consumer kitchen products, including the subject “NuWave 6Q Nutri-Pot 6Q Digital Pressure Cooker,” which specifically includes the Model Number 33101 (referred to hereafter as “pressure cooker(s)”) that is at issue in this case.

2. Defendant touts the “safety”¹ of its pressure cookers, and states that they cannot be opened while in use. Despite Defendant’s claims of “safety,” they designed, manufactured, marketed, imported, distributed and sold, both directly and through third-party retailers, a product

¹ See, e.g. NuWave Nutri-Pot® 6Q Digital Pressure Cooker Owner’s manual, pgs. 3, 13, 14, 15. A copy of the Owner’s manual is attached hereto as “Exhibit A”.

that suffers from serious and dangerous defects. Said defects cause significant risk of bodily harm and injury to its consumers.

3. Specifically, said defects manifest themselves when, despite Defendant's statements, the lid of the pressure cooker is removable with built-up pressure, heat and steam still inside the unit. When the lid is removed under such circumstances, the pressure trapped within the unit causes the scalding hot contents to be projected from the unit and into the surrounding area, including onto the unsuspecting consumers, their families and other bystanders. The Plaintiff in this case was able to remove the lid while the pressure cooker retained pressure, causing her serious and substantial bodily injuries and damages including, but not limited to,

4. Defendant knew or should have known of these defects, but has nevertheless put profit ahead of safety by continuing to sell its pressure cookers to consumers, failing to warn said consumers of the serious risks posed by the defects, and failing to recall the dangerously defective pressure cookers regardless of the risk of significant injuries to Plaintiff and consumers like her.

5. Defendant ignored and/or concealed its knowledge of these defects in its pressure cookers from the Plaintiff in this case, as well as the public in general, in order to continue generating a profit from the sale of said pressure cookers, demonstrating a callous, reckless, willful, depraved indifference to the health, safety and welfare of Plaintiff and consumers like her.

6. As a direct and proximate result of Defendant NuWave' collective conduct, the Plaintiff in this case incurred significant and painful bodily injuries, medical expenses, lost wages, physical pain, mental anguish, and diminished enjoyment of life.

PLAINTIFF KATHY BEVERLY

7. Plaintiff is a resident and citizen of the city of Avondale Estates, County of Dekalb, State of Georgia.

8. In or around September 2017, Plaintiff purchased a new pressure cooker, Model Number 33101.

9. On or about October 15, 2017, Plaintiff suffered serious and substantial burn injuries as the direct and proximate result of the pressure cooker's lid being able to be rotated and opened while the pressure cooker was still under pressure, during the normal, directed use of the pressure cooker, allowing its scalding hot contents to be forcefully ejected from the pressure cooker and onto Plaintiff. The incident occurred as a result of the failure of the pressure cooker's supposed "Sure-Lock® Safety System,"² which purports to keep the consumer safe while using the pressure cooker. In addition, the incident occurred as the result of Defendant's failure to redesign the pressure cooker, despite the existence of economical, safer alternative designs.

DEFENDANT NUWAVE, LLC.

10. Defendant NuWave designs, manufactures, markets, imports, distributes and sells a variety of consumer kitchen products including pressure cookers, juicers, coffee makers, and air-fryers, amongst others.

11. Defendant NuWave boast that "the Nutri-Pot can easily prepare virtually any meal you can imagine"³ with the "philosophy" that it is "driven by the pursuit of safe, environmentally friendly products that can improve the quality of life" and "committed to creating superior products that are affordable and make day-to-day life easier and healthier."⁴

² *Id.* at pgs. 13 - 15.

³ https://www.nuwavenow.com/NuWaveNutriPot?rx=1&ref_version=DIRECT&TM=1569510313184 (last accessed September 26, 2019)

⁴ https://nuwavenow.com/AboutUs?ref_version=DIRECT (last accessed September 26, 2019)

12. Defendant NuWave is an Illinois limited liability company, with a principal place of business is located at 1795 Butterfield Road, Libertyville, Illinois 60048. It may be served with process by serving its Registered Agent, Mr. Hunsu Son, whose principal place of business is located at 1190 S. Elmhurst Road, Suite 203, Mount Prospect, Illinois 60056.

JURISDICTION AND VENUE

13. Venue in this Court is proper in that all times relevant to this action, Plaintiff was a resident and citizen of the city of Jackson, County of Jackson, State of Michigan.

14. Jurisdiction in this Court is proper in that Defendant NuWave have established sufficient minimum contacts with the State of Georgia through the sale and distribution of its products and are subject to personal jurisdiction in this Court. Defendant NuWave' negligent and wrongful acts or omissions caused injury in the State of Georgia and are subject to personal jurisdiction in this Court.

FACTUAL BACKGROUND

15. Defendant NuWave is engaged in the business of designing, manufacturing, warranting, marketing, importing, distributing and selling the pressure cookers at issue in this litigation.

16. Defendant NuWave aggressively warrants, markets, advertises and sell its pressure cookers as “best in class for performance, features & value”⁵ allowing consumers to cook “cook delicious meals quickly” and “infuse your meals with flavor”.⁶

17. For instance, Defendant NuWave claims that “safety is a core value at NuWave” and that its pressure cookers include “multiple independent safety features.”⁷

⁵https://www.nuwavenow.com/NuWaveNutriPot?rx=1&ref_version=DIRECT&TM=1569510313184 (last accessed September 26, 2019)

⁶ *Id.*

⁷https://www.nuwavenow.com/NuWaveNutriPot?rx=1&ref_version=DIRECT&TM=1569510313184 (last accessed September 26, 2019)

18. To further propagate its message, Defendant NuWave has, and continues to utilize numerous media outlets including, but not limited to, infomercials, social media websites such as YouTube, and third-party retailers. For example, the following can be found on YouTube entitled “NuWave 8-qt Nutri-Pot Pressure Cooker with Pot, Glass Lid, & Rack on QVC”:

- a. **“Safe pressure cooking.** How simple is this. I’m all about keeping it simple in the kitchen, so what do you do here? You load it with what you’re gonna cook; you lock it down, simply enough. ***It’s got a great lid on this.*** Now this new lid on here gives you a little whistle. ***You know when that lid is open.*** It tells you. You lock it; it has a Sure-Lock System. **Once this is locked down, it is locked down.** ***You don’t have to worry about pressure cooker blowing up or anything like this.*”**⁸
- b. “Lid goes down. This slides over. ***There’s a Sure-Lock button right here in the front – it is locked down;*** it’s gone back to the warming function.”⁹
- c. “It will depressurize on its own, ***taking the fear out of pressure cooking in here.*”**¹⁰

19. In a similar video from NuWave’s YouTube page entitled “NuWave Cooking Club - Hard Boiled Eggs” spokesperson David Oland boasts that the NuWave Nutri-Pot is “one of the best and safest on the market” and “with our Sure-Lock System, we make sure all of this [pressure] is out; and [the Nutri-Pot has] a couple of really good safety features on this unit; if all the steams not out, you’re not opening this unit.”¹¹

20. According to the Owner’s Manual accompanying each individual unit sold, the pressure cookers purport to be designed with a “Sure-Lock® Safety System,”¹² which includes the misleading the consumer into believing that the pressure cookers are reasonably safe for their normal, intended use. Said “Sure-Lock® Safety System” includes, but is not limited to, the following:

⁸ https://www.youtube.com/watch?v=qR31q6hZ_OE at 0:43 – 1:12. (last accessed September 26, 2019)

⁹ *Id.* at 3:25 – 3:30.

¹⁰ *Id.* at 6:34 – 6:38.

¹¹ *Id.* 3:27 – 3:37.

¹² See NuWave Nutri-Pot® 6Q Digital Pressure Cooker Owner’s manual, pg. 14.

- a. **Lid Lock:** The 3-point Lid Lock system locks the lid in place at three independent points. It ensures that the unit will not pressurize unless the lid is completely closed. Once the Nutri-Pot is pressurized the lid will not open.
- b. **Maintaining Pressure:** The Bottom Pressure Switch monitors the cooking chamber and helps keep the unit at the perfect pressure. The Lower Disc is designed to release pressure automatically if the Nutri-Pot ever becomes over-pressurized.
- c. **The Food Blocking Cap:** The Food Blocking Cap ensures that the pressure vents smoothly. It covers the inside of the release valve and prevents foods or liquids from clogging the valve.

21. By reason of the forgoing acts or omissions, the above-named Plaintiff and/or her family purchased the pressure cooker with the reasonable expectation that it was properly designed and manufactured, free from defects of any kind, and that it was safe for its intended, foreseeable use of cooking.

22. Plaintiff used her pressure cooker for its intended purpose of preparing meals for herself and/or family and did so in a manner that was reasonable and foreseeable by the Defendant NuWave.

23. However, the aforementioned pressure cooker was defectively and negligently designed and manufactured by Defendant NuWave in that it failed to properly function as to prevent the lid from being removed with normal force while the unit remained pressurized, despite the appearance that all the pressure had been released, during the ordinary, foreseeable and proper use of cooking food with the product; placing the Plaintiff, her family, and similar consumers in danger while using the pressure cookers.

24. Defendant NuWave's pressure cookers possess defects that make them unreasonably dangerous for their intended use by consumers because the lid can be rotated and opened while the unit remains pressurized.

25. Further, Defendant NuWave's representations about "safety" are not just misleading, they are flatly wrong, and put innocent consumers like Plaintiff directly in harm's way.

26. Economic, safer alternative designs were available that could have prevented the Pressure Cooker's lid from being rotated and opened while pressurized.

27. Defendant NuWave knew or should have known that its pressure cookers possessed defects that pose a serious safety risk to Plaintiff and the public. Nevertheless, Defendant NuWave continues to ignore and/or conceal its knowledge of the pressure cookers' defects from the general public and continues to generate a substantial profit from the sale of their pressure cookers, demonstrating a callous, reckless, willful, depraved indifference to the health, safety and welfare of Plaintiff and consumers like her.

28. As a direct and proximate result of Defendant NuWave's intentional concealment of such defects, its failure to warn consumers of such defects, its negligent misrepresentations, its failure to remove a product with such defects from the stream of commerce, and its negligent design of such products, Plaintiff used an unreasonably dangerous pressure cooker, which resulted in significant and painful bodily injuries upon Plaintiff's simple removal of the lid of the Pressure Cooker.

29. Consequently, the Plaintiff in this case seeks compensatory damages resulting from the use of Defendant NuWave's pressure cooker as described above, which has caused the Plaintiff to suffer from serious bodily injuries, medical expenses, physical pain, mental anguish, diminished enjoyment of life, and other damages.

CLAIMS FOR RELIEF

COUNT I
STRICT LIABILITY

30. Plaintiff incorporates by reference each preceding and succeeding paragraph as though set forth fully at length herein.

31. At the time of Plaintiff's injuries, Defendant NuWave's pressure cookers were defective and unreasonably dangerous for use by foreseeable consumers, including Plaintiff.

32. Defendant NuWave's pressure cookers were in the same or substantially similar condition as when they left the possession of Defendant NuWave.

33. Plaintiff did not misuse or materially alter the pressure cooker.

34. The pressure cookers did not perform as safely as an ordinary consumer would have expected them to perform when used in a reasonably foreseeable way.

35. Further, a reasonable person would conclude that the possibility and seriousness of harm outweighs the burden or cost of making the pressure cookers safe. Specifically:

- a. The pressure cookers designed, manufactured, sold, and supplied by Defendant NuWave were defectively designed and placed into the stream of commerce in a defective and unreasonably dangerous condition for consumers;
- b. The seriousness of the potential burn injuries resulting from the product drastically outweighs any benefit that could be derived from its normal, intended use;
- c. Defendant NuWave failed to properly market, design, manufacture, distribute, supply, and sell the pressure cookers, despite having extensive knowledge that the aforementioned injuries could and did occur;
- d. Defendant NuWave failed to warn and place adequate warnings and instructions on the pressure cookers;
- e. Defendant NuWave failed to adequately test the pressure cookers; and
- f. Defendant NuWave failed to market an economically feasible alternative design, despite the existence of economical, safer alternatives, that could have prevented the Plaintiff's injuries and damages.

36. Defendant NuWave actions and omissions were the direct and proximate cause of the Plaintiff's injuries and damages.

37. Defendant NuWave conduct, as described above, was extreme and outrageous. Defendant NuWave risked the safety and well-being of the consumers and users of their pressure cookers, including the Plaintiff to this action, with the knowledge of the safety and efficacy problems and suppressed this knowledge from the public. Defendant NuWave made conscious decisions not to redesign, warn or inform the unsuspecting consuming public. Defendant NuWave's outrageous conduct warrants an award of punitive damages.

WHEREFORE, Plaintiff demands judgment against Defendant NuWave for compensatory, treble, and punitive damages, together with interest, costs of suit, attorneys' fees, and all such other relief as the Court deems proper.

COUNT II
NEGLIGENCE

38. Plaintiff incorporates by reference each preceding and succeeding paragraph as though set forth fully at length herein.

39. Defendant NuWave had a duty of reasonable care to design, manufacture, market, and sell non-defective pressure cookers that are reasonably safe for their intended uses by consumers, such as Plaintiff and her family.

40. Defendant NuWave failed to exercise ordinary care in the manufacture, sale, warnings, quality assurance, quality control, distribution, advertising, promotion, sale and marketing of its pressure cookers in that Defendant NuWave knew or should have known that said pressure cookers created a high risk of unreasonable harm to the Plaintiff and consumers alike.

41. Defendant NuWave was negligent in the design, manufacture, advertising, warning, marketing and sale of its pressure cookers in that, among other things, it:

- a. Failed to use due care in designing and manufacturing the pressure cookers to avoid the aforementioned risks to individuals;
- b. Placed an unsafe product into the stream of commerce;

- c. Aggressively over-promoted and marketed its pressure cookers through television, social media, and other advertising outlets; and
- d. Were otherwise careless or negligent.

42. Despite the fact that Defendant NuWave knew or should have known that consumers were able to remove the lid while the Ppressure cookers were still pressurized, Defendant NuWave continued to market (and continue to do so) its pressure cookers to the general public.

43. Defendant NuWave's conduct, as described above, was extreme and outrageous. Defendant NuWave risked the safety and well-being of the consumers and users of their pressure cookers, including the Plaintiff to this action, with the knowledge of the safety and efficacy problems and suppressed this knowledge from the public. Defendant NuWave made conscious decisions not to redesign, warn or inform the unsuspecting consuming public. Defendant NuWave's outrageous conduct warrants an award of punitive damages.

WHEREFORE, Plaintiff demands judgment against Defendant NuWave for compensatory, treble, and punitive damages, together with interest, costs of suit, attorneys' fees, and all such other relief as the Court deems proper.

COUNT III
BREACH OF EXPRESS WARRANTY

44. Plaintiff incorporates by reference each preceding and succeeding paragraph as though set forth fully at length herein.

45. Defendant NuWave expressly warranted that its pressure cookers were safe and effective to members of the consuming public, including Plaintiff. Moreover, Defendant NuWave expressly warranted that the lid of the Pressure Cooker could not be removed while the unit remained pressurized. For example:

- a. **Lid Lock:** The 3-point Lid Lock system locks the lid in place at three independent points. *It ensures that the unit will not pressurize unless the lid is completely closed. Once the Nutri-Pot is pressurized the lid will not open.*¹³

46. Members of the consuming public, including consumers such as the Plaintiff were the intended third-party beneficiaries of the warranty.

47. Defendant NuWave marketed, promoted and sold its pressure cookers as a safe product, complete with a “Sure-Lock® Safety System.”

48. Defendant NuWave’s pressure cookers do not conform to this express representation because the lid can be removed using normal force while the units remain pressurized, despite the appearance that the pressure has been released, making the pressure cookers not safe for use by consumers.

49. Defendant NuWave breached its express warranties in one or more of the following ways:

- a. The pressure cookers as designed, manufactured, sold and/or supplied by the Defendant NuWave, were defectively designed and placed into the stream of commerce by Defendant NuWave in a defective and unreasonably dangerous condition;
- b. Defendant NuWave failed to warn and/or place adequate warnings and instructions on their pressure cookers;
- c. Defendant NuWave failed to adequately test its pressure cookers; and
- d. Defendant NuWave failed to provide timely and adequate post-marketing warnings and instructions after they knew the risk of injury from their pressure cookers.

50. The Plaintiff in this case and/or her family purchased and used the pressure cooker with the reasonable expectation that it was properly designed and manufactured, free from defects of any kind, and that it was safe for its intended, foreseeable use of cooking.

¹³ *Id.*

51. Plaintiff's injuries were the direct and proximate result of Defendant NuWave's breach of its express warranties.

52. Defendant NuWave's conduct, as described above, was extreme and outrageous. Defendant NuWave risked the safety and well-being of the consumers and users of its Pressure cookers, including the Plaintiff to this action, with the knowledge of the safety and efficacy problems and suppressed this knowledge from the public. Defendant NuWave made conscious decisions not to redesign, warn or inform the unsuspecting consuming public. Defendant NuWave's outrageous conduct warrants an award of punitive damages.

WHEREFORE, Plaintiff demands judgment against Defendant NuWave for compensatory, treble, and punitive damages, together with interest, costs of suit, attorneys' fees, and all such other relief as the Court deems proper.

COUNT IV
BREACH OF IMPLIED WARRANTY OF FITNESS
FOR A PARTICULAR PURPOSE

53. Plaintiff incorporates by reference each preceding and succeeding paragraph as though set forth fully at length herein.

54. Defendant NuWave manufactured, supplied, and sold their pressure cookers with an implied warranty that they were fit for the particular purpose of cooking quickly, efficiently and safely.

55. Members of the consuming public, including consumers such as the Plaintiff, were the intended third-party beneficiaries of the warranty.

56. Defendant NuWave's pressure cookers were not fit for the particular purpose as a safe means of cooking, due to the unreasonable risks of bodily injury associated with their use as described herein in this Complaint.

57. The Plaintiff in this case reasonably relied on Defendant NuWave's representations that its pressure cookers were a quick, effective and safe means of cooking.

58. Defendant NuWave's breach of the implied warranty of fitness for a particular purpose was the direct and proximate cause of Plaintiff's injuries and damages.

59. Defendant NuWave's conduct, as described above, was extreme and outrageous. Defendant NuWave risked the safety and well-being of the consumers and users of its Pressure cookers, including the Plaintiff to this action, with the knowledge of the safety and efficacy problems and suppressed this knowledge from the public. Defendant NuWave made conscious decisions not to redesign, warn or inform the unsuspecting consuming public. Defendant NuWave's outrageous conduct warrants an award of punitive damages.

WHEREFORE, Plaintiff demands judgment against Defendant NuWave for compensatory, treble, and punitive damages, together with interest, costs of suit, attorneys' fees, and all such other relief as the Court deems proper.

COUNT V
BREACH OF IMPLIED WARRANTY OF MERCHANTABILITY

60. Plaintiff incorporates by reference each preceding and succeeding paragraph as though set forth fully at length herein.

61. At the time Defendant NuWave marketed, distributed and sold their pressure cookers to the Plaintiff in this case, Defendant NuWave warranted that its Pressure cookers were merchantable and fit for the ordinary purposes for which they were intended.

62. Members of the consuming public, including consumers such as the Plaintiff, were intended third-party beneficiaries of the warranty.

63. Defendant NuWave's pressure cookers were not merchantable and fit for their ordinary purpose, because they had the propensity to lead to the serious personal injuries as described herein in this Complaint.

64. The Plaintiff in this case and/or her family purchased and used the pressure Cooker with the reasonable expectation that it was properly designed and manufactured, free from defects of any kind, and that it was safe for its intended, foreseeable use of cooking.

65. Defendant NuWave's breach of implied warranty of merchantability was the direct and proximate cause of Plaintiff's injury and damages.

66. Defendant NuWave's conduct, as described above, was extreme and outrageous. Defendant NuWave risked the safety and well-being of the consumers and users of their pressure cookers, including the Plaintiff to this action, with the knowledge of the safety and efficacy problems and suppressed this knowledge from the public. Defendant NuWave made conscious decisions not to redesign, warn or inform the unsuspecting consuming public. Defendant Sunbeam's outrageous conduct warrants an award of punitive damages.

WHEREFORE, Plaintiff demands judgment against Defendant NuWave for compensatory, treble, and punitive damages, together with interest, costs of suit, attorneys' fees, and all such other relief as the Court deems proper.

COUNT VI
VIOLATION OF THE ILLINOIS UNIFORM DECEPTIVE TRADE PRACTICES ACT
815 ILCS 510 et. seq.

67. Plaintiff incorporates by reference each preceding and succeeding paragraph as though set forth fully at length herein.

68. At all times material herein, Defendant NuWave warranted and represented that its pressure cookers were safe and free of defects in materials and workmanship and that they possessed a "safety system".

69. Defendant NuWave warranties and representations that their pressure cookers were safe and free from defects, including that they possessed a “safety system,” would influence a reasonable consumer’s decision whether to purchase the pressure cookers.

70. Defendant NuWave’s failure to warn of its pressure cookers defects was a material omission that would influence a reasonable consumer’s decision whether to purchase its pressure cookers.

71. Plaintiff and/or her family relied on the truth of Defendant NuWave’s warranties and representations concerning the pressure cookers, and Plaintiff suffered personal damages as result of this reliance.

72. Had Plaintiff and/or her family been adequately warned concerning the likelihood that the pressure cooker’s lid could be removed while pressurized, they would have taken steps to avoid damages by not purchasing this product. As a result of these violations of consumer protection laws, the Plaintiff in this case has incurred and will incur: serious physical injury, pain, suffering, loss of income, loss of opportunity, loss of family and social relationships, and medical and hospital expenses and other expense related to the diagnosis and treatment thereof, for which the Defendant NuWave are liable.

WHEREFORE, Plaintiff demands judgment against Defendant NuWave for compensatory, treble, and punitive damages, together with interest, costs of suit, attorneys’ fees, and all such other relief as the Court deems proper.

COUNT VII
PUNITIVE DAMAGES

73. Plaintiff incorporates by reference each of the allegations set forth in this Complaint as though fully set forth herein.

74. The acts, conduct, and omissions of Defendant NuWave, as alleged throughout this Complaint, were willful and malicious. It is unconscionable and outrageous that Defendant NuWave would risk the health, safety, and well-being of consumers, including the Plaintiff in this case. Despite its knowledge that the lid could be prematurely removed while the unit remained pressurized, Defendant NuWave made conscious decisions not to redesign, despite the existence of an economically feasible, safer alternative design, and not to adequately label, warn or inform the unsuspecting consuming public about the dangers associated with the use of its pressure cookers. Defendant NuWave's outrageous conduct rises to the level that Plaintiff should be awarded punitive damages to deter Defendant NuWave from this type of outrageous conduct in the future, as well as to discourage other Defendant NuWave from placing profits above the safety of consumers in the United States of America.

75. Prior to and during the manufacturing, sale, and distribution of their pressure cookers, Defendant NuWave knew that said pressure cookers were in a defective condition as previously described herein and knew that those who purchased and used their pressure cookers, including Plaintiff, could experience severe physical, mental, and emotional injuries.

76. Further, Defendant NuWave knew that its pressure cookers presented a substantial and unreasonable risk of harm to the public, including Plaintiff, and as such, Defendant NuWave unreasonably subjected consumers of said pressure cookers to risk of serious and permanent injury from their use.

77. Despite its knowledge, Defendant NuWave, for the purpose of enhancing its profits, knowingly and deliberately failed to remedy the known defects in its pressure cookers, and failed to warn the public, including Plaintiff, of the extreme risk of injury occasioned by said defects inherent in them. Defendant NuWave intentionally proceeded with the manufacturing, sale, distribution and marketing of its pressure cookers knowing these actions would expose consumers,

such as the Plaintiff, to serious danger in order to advance its pecuniary interest and monetary profits.

78. Defendant NuWave's conduct was despicable and so contemptible that it would be looked down upon and despised by ordinary decent people and was carried on by Defendant NuWave with willful and conscious disregard for the safety of the Plaintiff, her family, and consumers like them, entitling the Plaintiff to punitive damages.

WHEREFORE, Plaintiff demands judgment against Defendant NuWave for compensatory, treble, and punitive damages, together with interest, costs of suit, attorneys' fees, and all such other relief as the Court deems proper.

PRAYER FOR RELIEF

WHEREFORE, Plaintiff demands judgment against the Defendant NuWave for damages, including exemplary damages if applicable, to which they entitled by law, as well as all costs of this action, interest and attorneys' fees, to the full extent of the law, whether arising under the common law and/or statutory law, including:

- a. judgment for Plaintiff and against Defendant NuWave;
- b. damages to compensate Plaintiff for her injuries, economic losses and pain and suffering sustained as a result of the use of the Defendant NuWave's pressure cookers;
- c. pre and post judgment interest at the lawful rate;
- d. exemplary, punitive, and treble damages on all applicable Counts as permitted by the law;
- e. a trial by jury on all issues of the case;
- f. an award of attorneys' fees; and
- g. for any other relief as this Court may deem equitable and just, or that may be available under the law of another forum to the extent the law of another forum is applied, including but not limited to all reliefs prayed for in this Complaint and in the foregoing Prayer for Relief.

Respectfully submitted,

Date: October 10, 2019

BY: /s/ Timothy S. Tomasik
Attorney for Plaintiff

TOMASIK, KOTIN & KASSERMAN, LLC

Timothy S. Tomasik
Loren Legorreta
161 N. Clark St., Suite 3050
Chicago, Illinois 60601
(312) 605-8800
tim@tkklaw.com
loren@tkklaw.com

JOHNSON BECKER, PLLC

Michael K. Johnson, Esq. (MN ID #0258696)
Kenneth W. Pearson, Esq. (MN ID #016088X)
Adam J. Kress, Esq. (MN ID #0397289)
444 Cedar Street, Suite 1800
St. Paul, MN 55101
(612) 436-1800
mjohnson@johnsonbecker.com
kpearson@johnsonbecker.com
akress@johnsonbecker.com

Pro Hac Vice to be filed

Pro Hac Vice to be filed

Pro Hac Vice to be filed

EXHIBIT A

NuWave Nutri-Pot® 6Q Digital Pressure Cooker Owner's Manual

nuwave[®]
— LIVE WELL FOR LESS —

**RECIPES
INCLUDED!**

NuWave Nutri-Pot[®] 6Q Digital Pressure Cooker



Owner's Manual & Complete Recipe Book

Nuwave Brio® Air Fryer



NuWave Oven® Pro Plus



NuWave Brio® Digital Air Fryer

Super-heated air cooks your food to crispy, tender perfection. The digital touch screen gives you precise temperature control.

NuWave Electric Skillet

Coated with Duralon® Healthy Ceramic Non-Stick for easy cleanup. Includes a premium tempered glass lid.

NuWave Oven® Pro Plus

Cook healthier meals faster and more efficiently with Triple Combo Cooking Power.

More about our innovative products, visit:

**NuWave Nutri-Pot® 6Q
Digital Pressure Cooker**



NuWave Electric Skillet



NuWave PIC®



NuWave PIC®

(Precision Induction Cooktop)

Cook faster, safer and more efficiently than you ever could on your gas or electric stovetop.

**NuWave Nutri-Pot® 6Q
Digital Pressure Cooker**

Easily cook rice, poultry, vegetables, and more all with the press of a button! The Nutri-Pot's safety release valve and hinged lid make for convenient and safe operation.

www.NuWaveNow.com

 1-877-689-2838

**Flavor Lockers™
with Vacuum-Seal Technology**



**NuWave Flavor-Lockers™
with Vacuum-Seal Technology**

Keep food fresh for 21 days! Remove the oxygen with a few easy pumps. Slow the growth of mold by removing trapped oxygen.

**NuWave Nutri-Master®
Slow Juicer**

The Nutri-Master with a low 48 RPM is incredibly quiet and powerful enough to extract juice from nut and hard vegetables.

More about our innovative products, visit:

Nutri-Master® Slow Juicer

**Duralon® Healthy Ceramic
Non-Stick Cookware**



Duralon® Healthy Ceramic Non-Stick Cookware

Coated with Duralon Healthy Ceramic Non-Stick for easy cleanup, this versatile cookware is perfect for use in the oven as well as on gas, electric, and even induction cooktops.

www.NuWaveNow.com

 1-877-689-2838

TABLE OF CONTENTS

OWNER'S MANUAL

Important Safeguards	7-8
Additional Safeguards.....	9-10
Care & Maintenance	11
Parts Descriptions.....	112
Product Features	13-14
Operating Instructions.....	15-16
Silicone Gasket Installation.....	16
Save These Instructions	17

Control Panel	18-20
----------------------------	--------------

Preset Guide	21
---------------------------	-----------

Functions	21-24
------------------------	--------------

Time	22
Texture	22
Delay.....	23
Warm	23
Sear	24
Slow Cook.....	24

Pressure Canning.....	25-28
------------------------------	--------------

Troubleshooting Guide	29
------------------------------------	-----------

Warranty	30
-----------------------	-----------

Pressure Cooking Notes.....	31
------------------------------------	-----------

Soups

Andouille Sausage & Cabbage Soup.....	33
Barley Beef Soup	34
Chicken & Rice Soup.....	35

Poultry

Cassoulet Chicken	37
Chicken a la King	38
Salsa Chicken and Rice.....	39

Beef

Beef Mac & Cheese.....	41
Beef Short Ribs.....	42
Spicy Beef and Cabbage	43

BBQ & Meats

Baby Back Ribs.....	45
BBQ Pulled Pork	46
Honey BBQ Meatloaf	47
Pork Shoulder with Sauerkraut	48
Pot Roast	49
Swiss Steak	50
Braised Lamb Shanks.....	51
Sailor's Mussels.....	52

Veggies, Pastas & Sauces

Hash Brown Frittata	54
Blistered Cherry Tomato Stuffed Peppers.....	55
Stuffed Squash	56
Classic Chill	57
Risotto with Italian Sausage & Parmesan.....	58
Jambalaya.....	59
Garlic Cheddar Mashed Potatoes.....	60
Mariana Sauce.....	61
Rice and Beans.....	62
Tortellini.....	63

Baking

Box Cake Mix.....	65
Orange Cheesecake	66
Brownies	67

IMPORTANT SAFEGUARDS

READ ALL INSTRUCTIONS

When using electrical units, basic safety precautions should always be followed including the following:

1. **Do not touch hot surfaces.** Use handle.
2. To protect against electrical shock, do not immerse cord, plugs, or the unit in water or other liquid.
3. Close supervision is necessary when any unit is used by or near children.
4. Unplug from outlet when not in use and before cleaning. Allow unit to cool before adding on or removing off parts.
5. Do not operate any unit with a damaged cord or plug, after the unit malfunctions or it has been damaged in any manner. **In case the unit is malfunctioning, please contact Customer Service at 1-877-689-2838 or via email help@nuwavenow.com.**
6. The use of other accessories that are not intended to be use with this unit is not recommended. Doing so may damage the unit and can cause accidents.
7. **NOT INTENDED FOR OUTDOOR USE.**
8. Do not let cord hang over edge of table or counter, or touch hot surfaces.
9. Do not place on or near a hot gas or electric burner and or in a heated oven.
10. Extreme caution must be used when moving a unit containing hot oil or other hot liquids.
11. Always attach the plug to the unit first, then plug the cord into the wall outlet. To disconnect, turn any control "OFF", then remove plug from the wall outlet.
12. Always check the pressure release devices for clogging before use.
13. **DO NOT place any object above the pressure release valve as this is steam being released from the NuWave Nutri-Pot® Digital Pressure Cooker.**
14. **DO NOT USE THE UNIT FOR OTHER THAN INTENDED USE.**

IMPORTANT SAFEGUARDS (Continued)



CAUTION



- a) A short power-supply cord should be provided to reduce risks resulting from becoming entangled in or tripping over a longer cord.
- b) Longer detachable power-supply cord are available and may be used if care is exercised in their use.
- c) If a long detachable power-supply cord is used:
 - 1) The marked electrical rating of the detachable power-supply cord should be at least as great as the electrical rating of the unit.
 - 2) If the unit is of the grounded type, the extension cord should be a grounding type 2-wire cord; and
 - 3) The longer cord should be arranged so that it will not drape over the counter top or table top where it can be pulled on by children or tripped over unintentionally.

ADDITIONAL SAFEGUARDS

1. If you cook meat with skin, such as sausage, swelling can occur when cooked under pressure. Piercing skin after cooking can lead to bursts of hot liquid.
2. Do not lean over the NuWave Nutri-Pot Digital Pressure Cooker at any time while it is cooking.
3. The NuWave Nutri-Pot Digital Pressure Cooker should not be used for any medical purposes. It is not designed to reach the required temperature for sterilization.
4. The Silicone Gasket creates a pressure seal between lid and pot. Keep the gasket completely clean and free from any cracks or deterioration.
5. It is extremely important to fill the NuWave Nutri-Pot Digital Pressure Cooker with liquid prior to operation. Never cook without liquid as doing so can cause it to overheat and damage the safety mechanisms. In case of overheating, never remove the NuWave Nutri-Pot Digital Pressure Cooker from the heat source. Instead, shut it off immediately and let it cool.
6. Make sure all parts of the pressure regulator and ventilated pipe are clean and properly assembled.
7. Do not alter the safety mechanisms or attempt to repair the NuWave Nutri-Pot Digital Pressure Cooker as this will void the warranty. Please adhere to the Maintenance Instructions specified for use.
8. Use only the appropriate replacement parts from NuWave® to maintain proper functionality and safety. Visit www.NuWaveNow.com for replacement parts and pieces.
9. Do not place the unit close to flammable materials and heating units or wet environments.
10. Height of ingredients that is to be put into inner pot should comply with "Operation Instructions".
11. Do not break the Silicone Gasket. Do not replace it with other rubber gaskets, nor use a tension belt to make it seal.
12. Check and wash anti-clog filter and pressure release valve regularly to avoid being blocked.
13. Do not open the lid when the Floater Valve is down.
14. Do not put anything on or use other object to replace the Pressure Release Valve.
15. Never use a towel to clog the gap between the lid and edge of the Housing.
16. The bottom of the inner pot and heating plate should be kept clean. Do not put the inner pot on other heat sources. Do not replace the inner pot with other containers.

ADDITIONAL SAFEGUARDS (Continued)

17. Only use wood or plastic ladle spoons so not to ware the non-stick coating in the inner pot.
18. Do not attempt to move the unit while it is cooking. Only after the unit cools down completely can the it be moved. Move the unit using the body handles, do not try to hold in from the lid handle.
19. Do not disassemble on your own or try to replace with non-special worn parts.
20. Make sure the air/pressure discharges completely before opening the lid.
21. Fit on water collection box before use and add clean lid each use.
22. You may experience some smoke coming out the unit during the first few uses, this is normal.
23. **Contact our Customer Service Department at 1-877-689-2838 or via email help@nuwavenow.com for the following:**
 - If the main power cord is damaged.
 - In the case the unit emits a continuous amount of smoke while is use.

CARE & MAINTENANCE

- Unplug the NuWave Nutri-Pot® Digital Pressure Cooker prior to cleaning.
- Wipe the base and inside of the base, if necessary, with a clean cloth. Do not immerse the base in water or spray any water in it.



- Remove and clean the water collection box. Wipe with a wet towel and insert it back to the body of the NuWave Nutri-Pot® Digital Pressure Cooker.
- The lid can be detached from the base. See image on page 9 step 1 for proper operating instructions. All parts inside the lid can be hand washed separately with water and should always be checked to make sure they are not damaged or cracked.
- Use a sponge or non-metallic soft brush to clean the inner pot, then wipe the surface with a clean cloth.

PARTS DESCRIPTION

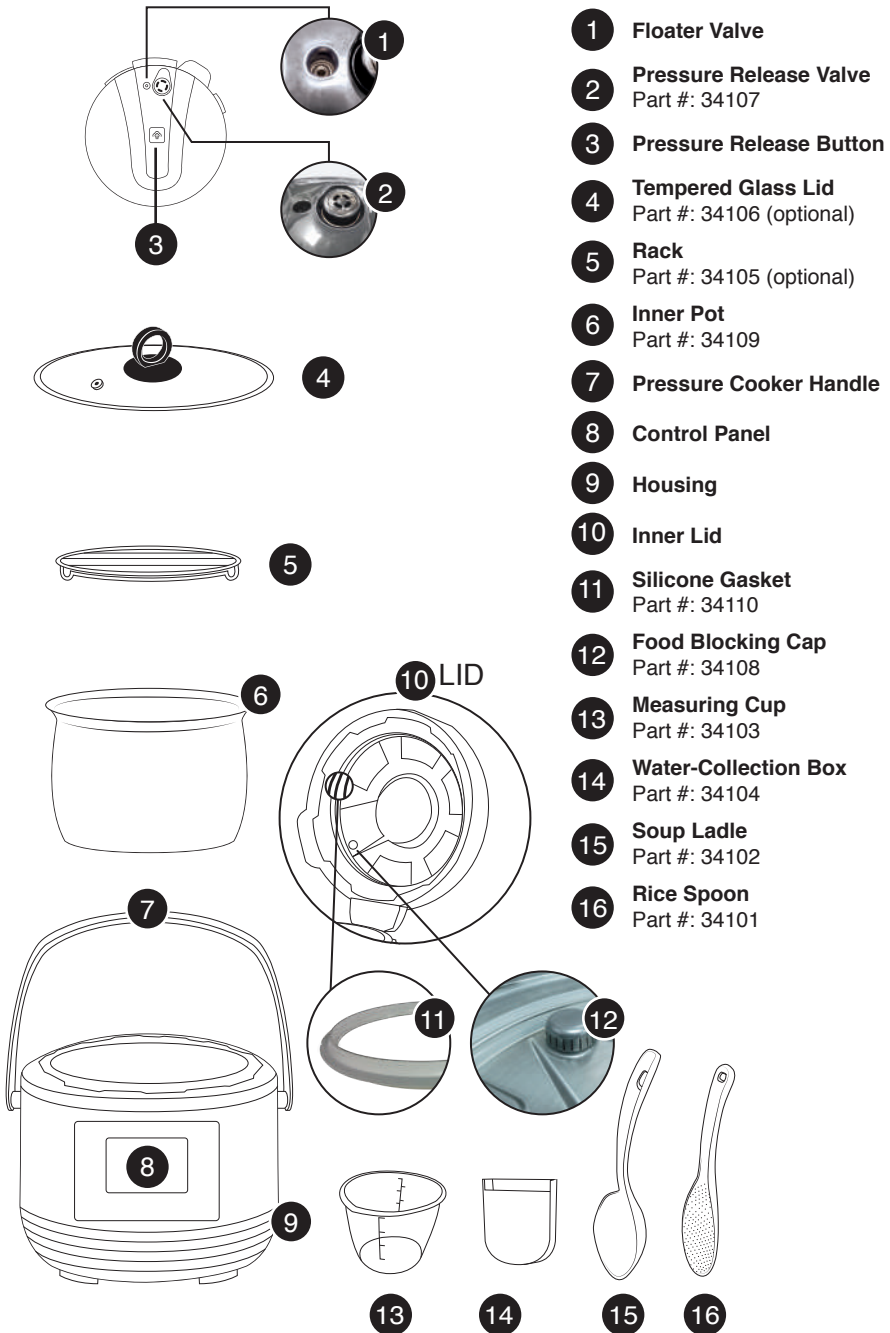

PRODUCT FEATURES

The **NuWave Nutri-Pot® Digital Pressure Cooker** combines the advantages of a Pressure Cooker, Rice Cooker and Slow Cooker all in one.

The advantages including structure, vanguard shape, enhanced safety settings, multiple functions, easy operation, saving time and energy and lock nutrition of food. It is an ideal unit for any modern home.

Benefits

The NuWave Nutri-Pot Digital Pressure Cooker consists of a cooking pot and a special lid that locks into place on the top of the pot. When it is heated, steam is sealed inside, which creates pressure. With this high pressure, the internal temperature of the NuWave Nutri-Pot Digital Pressure Cooker is raised above the normal boiling point of water. The cooking process is thus expedited leading to healthier meals made faster.

Multiple Cooking Functions

Now you can sear, stew, steam, simmer, bake, can, slow cook and keep your foods warm all by the push of a button.

Digital

Ingredients are automatically cooked to the right specifications.

During operation, the NuWave Nutri-Pot Digital Pressure Cooker will indicate which cooking function it is performing. Once finished, depending on the function, it will automatically switch to the Warm setting until you're ready to eat.

Preset Time Function

The NuWave Nutri-Pot Digital Pressure Cooker includes a Delay feature so you can start cooking exactly when you want.

Saved Memory

If the NuWave Nutri-Pot Digital Pressure Cooker is disconnected from its power supply and reconnected within 20 minutes, all programmed settings will be retained.

High Efficiency

Cooking in the NuWave Nutri-Pot Digital Pressure Cooker saves you time and energy.

Perfect Seal

The Silicone Gasket locks in the taste and nutrients of your favorite foods.

Easy to Clean

The inner pot is non-stick so it's easy to clean. The stainless steel lid is durable and detachable for easy cleaning.

Innovative Design

The NuWave Nutri-Pot Digital Pressure Cooker features a user friendly design that releases any excess steam away from the unit, ensuring peace of mind.

PRODUCT FEATURES (Continued)

Faster Cooking

On average, Pressure Cookers prepare food faster than traditional cooking methods and the NuWave Nutri-Pot Digital Pressure Cooker is no exception.

Tastier Meals

Pressure cooking allows food to retain its full flavor by cooking quickly and efficiently. With the natural flavor intact, less seasoning is required, enabling you to craft your meals precisely to your taste.

Healthier Results

More vitamins and minerals are retained in food prepared with the NuWave Nutri-Pot Digital Pressure Cooker compared to conventional stove top cooking. In addition, pressure cooking utilizes water in lieu of additional unhealthy oils or fat, virtually eliminating the need to add extra, unnecessary calories to your diet.

Multifunctional

The NuWave Nutri-Pot Digital Pressure Cooker can be used for steaming, simmering and stewing fresh or even frozen foods. You can even use it for canning and baking. Prepare everything from delicate soups and desserts to hearty meat dishes.

MULTIPLE SAFETY DEVICES

Sure Lock™ Technology

The NuWave Nutri-Pot® 6Q Digital Pressure Cooker is equipped with the revolutionary Sure Lock™ technology. It surpasses other pressure cookers in advanced safety features. Sure Lock™ is comprised of multiple independent safety features, such as:

Lid Lock: The 3-point Lid Lock system locks the lid in place at three independent points. It ensures that the unit will not pressurize unless the lid is completely closed. Once the Nutri-Pot is pressurized the lid will not open.

Maintaining Pressure: The Bottom Pressure Switch monitors the cooking chamber and helps keep the unit at the perfect pressure. The Lower Disc is designed to release pressure automatically if the Nutri-Pot ever becomes over-pressurized.

The Food Blocking Cap: The Food Blocking Cap ensures that the pressure vents smoothly. It covers the inside of the release valve and prevents foods or liquids from clogging the valve.

ADDITIONAL SAFETY FEATURES:

Pressure Release Safety Device: If the pressure exceeds the maximum level, the excess pressure will automatically discharge safely via the pressure relief valve.

Temperature Control: If the inner pot heats up while empty or if it exceeds the maximum temperature limit, the Pressure Cooker will automatically shut off.

Thermostat: Once the inner pot exceeds the maximum temperature limit, the NuWave Nutri-Pot Digital Pressure Cooker will automatically shut off.

OPERATING INSTRUCTIONS

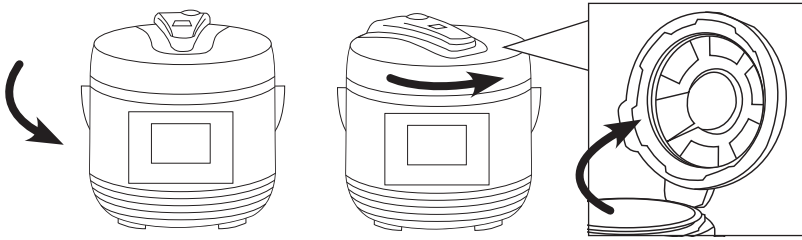

- 1 Open lid:** Hold the lid handle. Turn the lid counter clockwise to open position then raise it. (See above)



- 2** Place ingredients and water in the inner pot. Ingredients and water should not exceed $\frac{4}{5}$ height of the inner pot. If the ingredients expand easily in water, then the total amount should not exceed $\frac{3}{5}$ height of the inner pot. The minimum amount of ingredients and water is normally $\frac{1}{5}$ height of the inner pot. (See above).

- 3** Place the inner pot in the Housing. Clean the bottom of inner pot and surface of heating plate before inserting the inner pot. (See below).

- 4 Close lid:**
- Check that the Silicone Gasket is secured in the lid before closing.
 - Hold the lid handle. Lower the lid, then turn the lid clockwise to close. A sound will confirm that the lid has been closed properly. (See below).

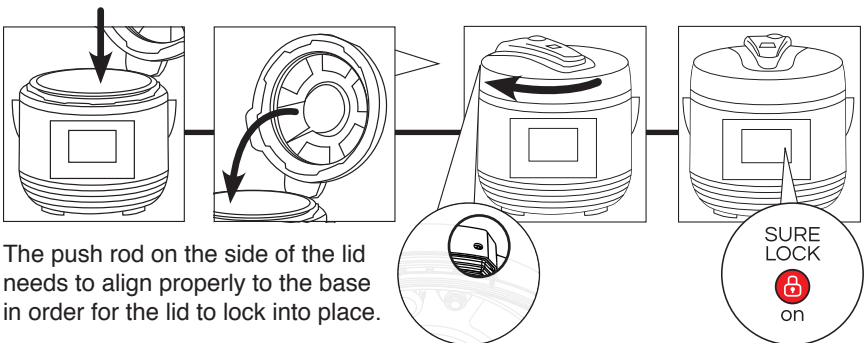

The push rod on the side of the lid needs to align properly to the base in order for the lid to lock into place.

- 5 Sure Lock™:**
- Once the lid is properly locked in place, the LED panel will display that the Sure Lock™ Safety Feature is activated.

OPERATING INSTRUCTIONS (Continued)

- 5 Once the lid is locked in place the Pressure Release Valve should be level.
- 6 Plug the NuWave Nutri-Pot Digital Pressure Cooker into an electric power supply. The LCD display will show "--:--" and the unit will go into standby mode.

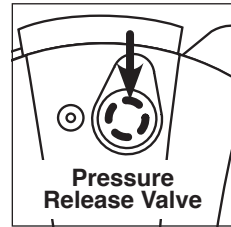

SILICONE GASKET INSTALLATION

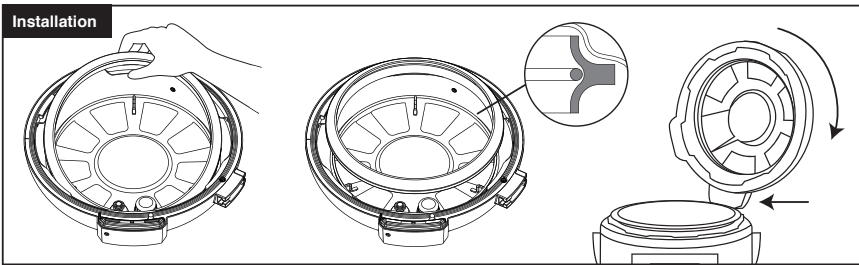
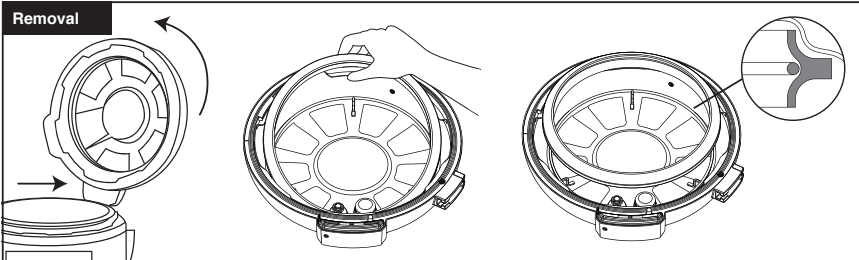

MAKE SURE THE SILICONE GASKET HAS NO CRACKS OR IS IN ANYWAY DAMAGED.

Remove Inner Lid from the Pressure Cooker.

- Rotate counter clockwise, this will detach the Inner Lid.
- With one hand holding the Inner Lid down, gently pull the Silicone Gasket up.

Installing the Silicone Gasket

- Line up the Silicone Gasket on top of the metal ring.
- Gently push the Silicone Gasket making sure you see the metal ring is inside the Silicone Gasket's groove. Continue pushing the Silicone Gasket all around.

SAVE THESE INSTRUCTIONS

1. Do not place the unit close to flammable materials heating units or wet environments.
2. Height of ingredients placed in the inner pot should comply with the directions listed under "Operation Instructions".
3. Do not break the Silicone Gasket. Do not replace it with other parts that are not designed specifically for the NuWave Nutri-Pot Digital Pressure Cooker.
4. Check and wash anti-clog filter and pressure release valve regularly to avoid blockage.
5. Do not attempt to open the lid when the floater is down.
6. Do not put anything on or use other objects to replace the pressure release valve.
7. Never use a towel to clog the gap between the lid and edge of Housing.
8. The cooking pot and heating plate should always be kept clean.
9. Do not put any other cooking pots on the heating plate. Do not replace any parts with other containers.
10. Do not use metal utensils with the coated cooking pot as this can damage the surface.
11. Keep hands and face away from the venting outlet or where pressure is being released.
12. Depending on the function, when cooking is complete, the NuWave Nutri-Pot Digital Pressure Cooker will automatically go to Warm Mode. Avoid letting ingredients sit in Warm Mode for more than 4 hours as this could affect the taste.
13. If a lot of smoke is escaping from the lid during operation, unplug the unit immediately and contact customer service.
14. Do not move the unit while in operation. Only after the NuWave Nutri-Pot Digital Pressure Cooker has completely cooled down should you attempt to move it. When moving the NuWave Nutri-Pot Digital Pressure Cooker, use the handle. Do not lift from the lid.
15. If any troubles arise during operation, any necessary service must be done by NuWave™, LLC or authorized by the manufacturer for repairs.
16. Do not disassemble the unit on your own or replace any parts.
17. If the power cord is damaged, do not attempt to operate the unit. Contact **Customer Service Department at help@nuwavenow.com** for assistance.
18. Keep the unit out of reach of children when the unit is operating or cooling down.
19. Place the water collection box in the NuWave Nutri-Pot Digital Pressure Cooker before every use. Make sure it is always cleaned prior to cooking.
20. It is normal for some smoke to escape the unit when heating for the first time.

CONTROL PANEL

Main Display Interface

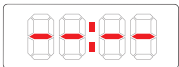

When unit is not cooking, or when no function has been selected, the LED screen will display “--:--” indicating that the unit is not in operation.



The “**delay**” bar will light up once the delay button has been pressed. This function will allow you to delay the start time of each preset function.



The “**manual**” bar will light up only when the time button has been pressed or when the cooking time has been changed manually. This will allow you to manually set your time for each function.



The “**less**”, “**normal**” and “**more**” bars light individually, indicating your current setting. The “**texture**” function applies to these displays with “**normal**” being the default setting. “**texture**” is a function that has 3 times pre-programmed for select presets. This also affects the consistency of your food.

All functions default to “normal”.

CONTROL PANEL (continued)

Figure 1 When making rice using our “rice” function, you can make sticky rice by setting the “texture” to “more” and if you want fluffier rice, set the “texture” to “less”.

Press “rice”, it will default to “normal” (00:10). Press “texture” to change to “more” (00:13). Press the “texture” button again to change to “less” (00:07). The bar will light up indicating what mode you are in. Press “start/stop” to begin.

Note (Applies to all):

- Pressing the “-” or “+” buttons will switch to “manual” mode.
- Press “start/stop” twice to clear.
- The Pressure Cooker will clear out in 30 seconds if the “start/stop” button is not pressed.

hours/minutes
This button will let you manually adjust the time. When the “hours/minutes” button is pressed, the 2 digits on the left will flash to indicate these are selected. Pressing the “+” and “-” buttons will increase and decrease the time.

minutes *hours*

Preheating: While the unit reaches the appropriate temperature for the function selected, the display will show “PH” indicating that it is preheating. Once the unit reaches the appropriate pressure, it will shift from preheating to the selected preset cooking time. Once pressure has built inside the Pressure Cooker, the PH display will change to P, followed by the amount of time it will remain under pressure.

Pressure: The function selected will determine the amount of pressure time. In this example, the display will show “P0:10” (pressure time). The colon or “:” will flash to indicate that the Pressure Cooker is under pressure and the timer is counting down.

Example:

Refer to the Preset Times Chart on page 21 for default times for each function.

CONTROL PANEL (continued)

Auto Warm Feature: When pressure cooking is complete, the NuWave Nutri-Pot® Digital Pressure Cooker will automatically switch to the warm function. This allows the pressure to naturally release while your food remains warm. The times for the presets are listed below.

Auto Warm Feature			
Presets	Indefinitely	Auto Shutoff	Time Hours: Minutes
Rice	☑		
Multi Grain	☑		
Soup			04:00
Meat/Stew			02:00
Poultry			01:00
Beans			04:00
Fish		☑	
Steam/Veggies		☑	
Potatoes			01:00
Bake		☑	
Canning		☑	
Warm (Function)			04:00

Example: When the “rice” preset is complete, the NuWave Nutri-Pot Digital Pressure Cooker will keep your “rice” warm indefinitely, until you press the “start/stop” button.

Note:

Food can be prepared at an earlier time and kept warm inside the Pressure Cooker using the “warm” function. Food can be kept warm for up to 4-hours. **Additional time may cause a change in flavor, appearance and cause food to spoil.**

PRESET GUIDE

Default Time		Texture			Time	
Presets & Functions	Hrs:Min	Less	Normal	More	Min.*	Max
Rice	00:10	00:07	00:10	00:13	00:01	01:40
Multi Grain	00:27	00:22	00:27	00:32	00:01	01:40
Soup	00:15	00:10	00:15	00:20	00:01	01:40
Meat/Stew	00:40	00:20	00:40	00:50	00:01	01:40
Poultry	00:20	00:15	00:20	00:25	00:01	01:40
Beans	00:20	00:15	00:20	00:25	00:01	01:40
Fish	00:08	00:06	00:08	00:10	00:01	01:40
Steam/Veggies	00:05	00:03	00:05	00:07	00:01	01:40
Potatoes	00:06	00:04	00:06	00:10	00:01	01:40
Bake	00:40	00:30	00:40	00:50	00:01	01:40
Canning	00:20				00:01	01:40
Delay					00:05	24:00
Warm	04:00				01:00	24:00
Sear	00:05				00:01	00:20
Slow Cook	04:00				02:00	09:00

*Minimum Time

The NuWave Nutri-Pot Digital Pressure Cooker is programmed to a set pressure of 70kPa. kPa as a unit of pressure measurement, is widely used throughout the world instead of the “Pounds per Square Inch, (PSI)” method. kPa to PSI ratio is approximately 7kPa to 1PSI.

For example: 2PSI is equal to 14kPa.



- 1** Press a preset button (Ex: “**rice**”). The main display will show the default time for this preset (Ex: 00:10). The digits to the right of the colon (“:”) display the minutes and the digits left of the colon display the hours. On the main panel, an LED bar will light up to indicate that the preset is on “**normal**” mode, which is the default.
- 2** To begin cooking, close the lid, then press the “**start/stop**” button.
- 3** See “**hours/minutes**” and “**texture**” sections for instructions on adjusting the time.

Example:



Follow these simple steps for each preset. On this example P0:10 is the default pressure time. The pressure time will vary depending on the preset you choose.

FUNCTIONS

Time: This function lets you manually adjust the cooking time, overriding the presets and functions.



Directions:

- 1 Press the “**time**” button. “**manual**” bar will light up and “00:01” will be flashing. This indicates that you can change the minutes.
- 2 Press the “+” or “-” button to increase or decrease the minutes.
- 3 To change hours press the “**hours/minutes**” button again. The “00” will be flashing. This indicates that you can change the hours.
- 4 Press the “+” or “-” button to increase or decrease the hours.

Example:

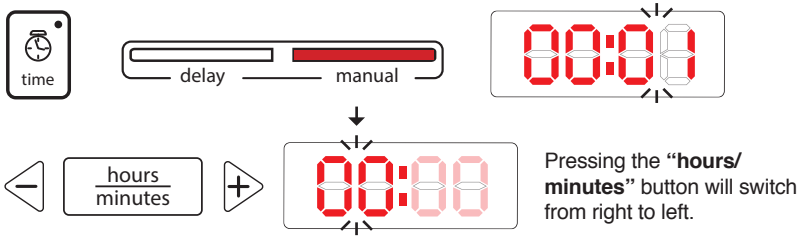

Texture: This is a function used to help change the consistency of your foods.



“**less**”, “**normal**” and “**more**” are selected guides that increase or decrease the cooking time while under pressure.

Directions:

- 1 Press a desired preset button. The display will default to “**normal**” time. (Ex: Press “**rice**” and the display will show 00:10).
- 2 To change the consistency of the food (less, normal, more), simply press “**texture**”. The appropriate light will display, indicating that the time has been changed. The time in the display will automatically adjust accordingly. (Ex: For the “**rice**” function, less is 7 minutes, normal is 10 minutes and more is 13 minutes).
- 3 Close the lid and press the “**start/stop**” button.
- 4 See page 21 for times for each function.

Example:

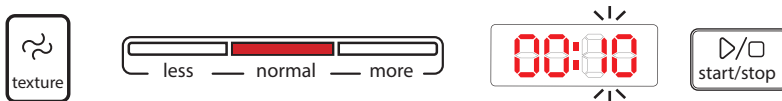

FUNCTIONS (Continued)

Delay: This function allows you to set a specific time you would like to start cooking.



Directions:

- 1 Press the **“delay”** button. The delay bar will light up and the first set of “00”s will be flashing.
- 2 Press the **“+”** or **“-”** button to increase or decrease the hours.
- 3 To change minutes press the **“hours/minutes”** button. The second set of “00”s will be flashing. This indicates that you can change the minutes.
- 4 Press the **“+”** or **“-”** button to increase or decrease the minutes.
- 5 Press the desired function button to continue your program based on your recipe.
- 6 Close the lid and press the **“start/stop”** button.

Note:

- When utilizing the delay function, it will always be the first function performed.
- You can adjust the delay time in 5-minute and 1-hour increments.
- The maximum amount of time to delay your Pressure Cooker is 24 hours.
- The delay function will not work while the Pressure Cooker is in operation.

Example:

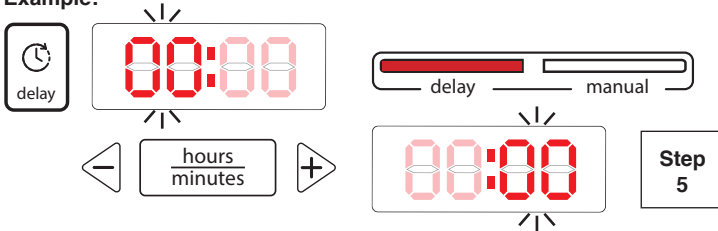

Warm: This function will let you manually adjust the time you would like to keep your food warm.



Directions:

- 1 Press the **“warm”** button, display will show “04:00”.
- 2 Press the **“+”** or **“-”** button to increase or decrease the time. *See “hours/minutes” section for instructions on adjusting the time.*
- 3 Press the **“start/stop”** button to start.

Note:

- The default time for the warm function is 4 hours, the minimum time is 1 hour and the maximum time is 24 hours.
- You can adjust the time in 5-minute and 1-hour increments.

*The Pressure Cooker will automatically go to this warm function when a desired preset has completed. Refer to the **Auto Warm Feature** chart on page 20 for default warm times.*

Example:

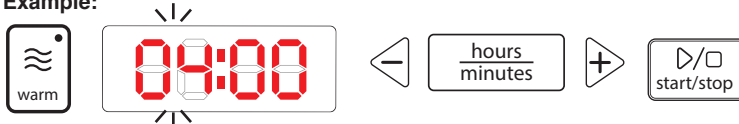

FUNCTIONS (Continued)

Sear: This function lets you “sear” your food before cooking under pressure or before using the Slow Cook function.



Directions:

- ➊ Press “sear” button. Display will show 00:05.
- ➋ Press “start/stop” button to begin.
- ➌ See the “hours/minutes” section for instructions on manually adjusting the time.

Note:

- Do not close lid when using “sear” function.
- The minimum time is 1 minute (00:01).
- The maximum time is 20 minutes (00:20).
- When complete, the display will show “End”.

Example:



Slow Cook: This function lets you cook various recipes slowly at low temperatures.



Directions:

- ➊ Press “slow” button. Display will show 04:00.
- ➋ Press “start/stop” button to begin.
- ➌ See “hours/minutes” section for instructions on adjusting the time.

Note:

- Do not close lid when using slow cook function.
- Use the optional glass lid when using the slow cook function.
- The minimum time is 2 hours (02:00).
- The maximum time is 9 hours (09:00).
- When complete, the display will show “End”.

Example:

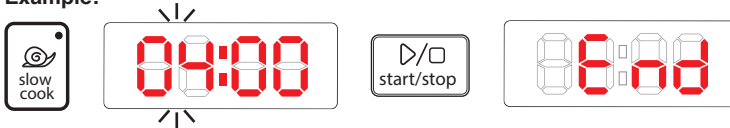

PRESSURE CANNING



Canning

Foods with lower acid content have a greater potential for spoilage and contamination than high acidity foods. Proper pressure canning minimizes the chances of spoilage and contamination.

High Acid Foods		Low Acid Foods	
Apples	Oranges	Asparagus	Mushrooms
Applesauce	Peaches	Beans	Okra
Apricots	Pears	Beets	Peas
Berries	Pickled Beets	Carrots	Potatoes
Cherries	Pineapples	Corn	Seafood
Cranberries	Plums	Hominy	Spinach
Fruit Juices	Rhubarb	Meat	Winter Squash

Never alter cooking times, temperatures or ingredients when pressure canning. Doing so can be extremely dangerous as there is no room for experimentation. Following the exact cooking times, temperatures and ingredients listed in the recipe will ensure that your food is protected from harmful enzymes, bacteria and mold. Altering the cooking time may destroy the food’s nutrients and flavor.

Enzymes found in food may promote growth of yeast and mold, which in turn causes food to spoil. These enzymes can be killed at temperatures 212°F and higher. Other contaminants, such as salmonella, staphylococcus aureus, and clostridium botulinum, can only be killed at temperatures 240°F. These higher temperatures can only be achieved by pressure canning.

Before pressure canning in the NuWave Nutri-Pot Digital Pressure Cooker, consult an instructional book written specifically for pressure canning. The NuWave Nutri-Pot Digital Pressure Cooker can be used for basic pressure canning, along with the water bath method. Both low and high acid fruits and vegetables are recommended. Meat and seafood are not recommended to be pressure canned.

PRESSURE CANNING (Continued)

Safe Canning Tips:

1. Do not use overripe fruit. Bad quality degrades with storage.
2. Do not add more low-acid ingredients (onions, celery, peppers, garlic, etc.) than specified in the written recipe. This may lead to an unsafe end result.
3. Don't use too many spices. Many spices tend to contain high levels of bacteria, which may result in unsafe canned goods.
4. Do not add butter or fat to the recipe. Fats do not store well and may cause premature spoilage. Never use thickeners such as flour, starch, pasta, rice or barley.
5. Use only USDA recommended tools and accessories.
6. Do add acid (lemon juice, vinegar or citric acid) especially to tomato products when directed in the recipe. If necessary, you can balance the tart taste by adding sugar.

The NuWave Nutri-Pot® Digital Pressure Canning Process

Though your exact experience may vary depending on the specific recipe you are following, most recipes can be prepared by following this guide.

1. Only follow recipes that have been tested for pressure canning. Prepare the necessary ingredients as instructed in the recipe.
2. Fill clean 16-ounce mason jars to the level. Do not allow ingredients to exceed the level. Always leave no less than 1 inch of head space.
3. Gently remove any lingering air bubbles by pressing a flexible, nonporous spatula between the ingredients and the jar itself.
4. Place a clean lid onto each jar, then add a screw band. Turn the lid clockwise and tighten in place.

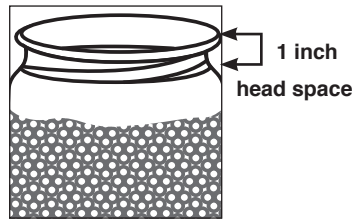

NOTE: Never re-tighten lids after pressurizing the jars. As the jars cool, the contents will contract, pulling the lid firmly against the jar to form a high vacuum and create a seal. If the screw bands are too loose, liquid may escape from the jars during this process, causing the seals to fail. If the screw bands are too tight, air cannot vent during this process, causing food to discolor while in storage. Tightening the lids too much may also cause the lids to buckle and the jars to break. Screw bands are not needed on stored jars.



Remove after jars have cooled. When removed, washed, dried and stored, screw bands may be used many times. If left on stored jars, they become difficult to remove, often rust, and may not work properly again.

PRESSURE CANNING (Continued)

5. Place the Inner Pot in the base unit. Then put the Wire Rack in the bottom of the Inner Pot. Place Filled, sealed Jars on Rack. Unit will hold up to 4-16 oz. jars (maximum).
6. Pour hot water over the jars and into the Inner Pot until the water level reaches 1/4 of the way up the sides of the jars. For 4-16oz cans. This would be about 6 cups of water. When processing fewer jars, more water would be needed.

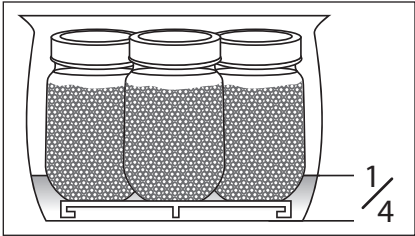

7. After reading the Owner’s Manual, put the lid on the base and lock in place. Plug the unit into the wall outlet.
8. Press the **“canning”** button, the Pressure Cooker will default to 20 minutes. To change pressure time, press the **“time”** button then adjust accordingly.
9. When the canning process is complete, the unit will shut off. Press the Pressure Release Button to release the pressure. Once all the steam has escaped, carefully remove the lid.
10. Using canning tongs, remove the hot jars and place them on a heat resistant surface and allow to cool to room temperature.
11. When jars are thoroughly cool, remove the screw bands. The lids should be tightly sealed to the jars and when pressed in the center they should not have any “give” or springing motion. If they do, you cannot safely store this food for future use. It must be reprocessed immediately or refrigerated and used within a few days.
12. Place the finished jars on shelves in a cool, clean, dry atmosphere. Properly processed food will last for months and seasons. Jars, lids and screw bands are reusable. Check all carefully for damage before reuse.

IMPORTANT: It is not recommended to use the NuWave Nutri-Pot Digital Pressure Cooker as a canning device at altitudes of 2,000 feet above sea level or higher.

NOTES & TIPS:

- While the jars are cooling, you will hear the lids emit a faint clicking sound. This sound indicates that the lids have properly sealed.
- You can check the seal on flat lids by pressing down with your thumb after they have cooled for one hour or more. If the lid remains stiff with no movement, then the lids have properly sealed.
- If the lids have not properly sealed after 2 hours of cooling, the pressure canning process did not work. Should this happen, refrigerate or freeze the ingredients and use within the standard use-by dates.
- Always use supplies specifically manufactured for the purpose of canning. For best results, use mason jars that are no larger than 16 ounces. When pressure canning, never stack the jars.

Use chart below. The canning function goes to a default of 20 minutes.

PRESSURE CANNING (Continued)

Food	Packing Conditions		Pressure 70kPa
	Type	Size (Jar)	Time (hrs:min)
Asparagus	Hot & Raw	Pints	00:30
Beans (green)	Hot & Raw	Pints	00:20
Beans (lima, pinto, butter or soy)	Hot & Raw	Pints	00:40
Beets	Hot	Pints	00:30
Carrots	Hot & Raw	Pints	00:25
Corn, Whole-kernel	Hot & Raw	Pints	00:55
Greens	Hot	Pints	01:10
Okra	Hot	Pints	00:25
Peas, Green or English	Hot & Raw	Pints	00:40
Potatoes, White	Hot	Pints	00:35

TROUBLESHOOTING GUIDE

PROBLEM	POSSIBLE CAUSE	RESOLUTION
Difficulty closing lid.	Silicone Gasket may not be placed correctly. Floater Valve may be blocking the push rod.	Place the Silicone Gasket correctly. Push the Floater Valve to the correct position.
Difficulty opening lid.	The Floater Valve may not be falling down properly. Pot may be still under pressure.	Push the Floater Valve Correctly.
Gas leakage from cooker lid.	Some ingredients may get stuck to the Silicone Gasket. Silicone gasket may be broken.	Clean the Silicone Gasket. Make sure that the lid is closed as per instructions on page 16.
Gas leakage from the Floater Valve.	Some ingredients may stick to the Floater Valve's sealing circle. The Floater Valve's sealing circle may be broken.	Clean the Anti-Clog Filter. The Floater Valve's sealing circle may need to be replaced.
Floater Valve does not raise up.	There may not be enough ingredients/water to generate enough pressure. Gas leakage from lid or Pressure Release Valve.	Ingredients or water need to be at minimum level. Unit may need to be sent to the manufacturer.
Pressure not building up	The lid is not properly locked in place.	Take the lid off and retry. Hold lid, lower it and turn clockwise to lock. (Refer to instructions on Pg.15.) LED panel will light up and display that Sure Lock™ Safety Feature is activated. Pressure will start building up after that.

If the unit needs to be replaced or returned to the manufacturer, please contact our Customer Service Department at: **1-877-689-2838 • help@nuwavenow.com**

Contact Customer Service if any of these errors occur

Code	E1	E2	E3	E4
Error	Broken circuit of sensor	Short circuit of sensor	Over heat	Signal switch broken



! WARNING

Please immediately cut off circuit and send unit to our Customer Service Department in case of other problems.

help@nuwavenow.com

WARRANTY

The NuWave™ Nutri-Pot® Digital Pressure Cooker

THE MANUFACTURER WARRANTIES

The NuWave Nutri-Pot Digital Pressure Cooker including the Pressure Release Valve, Pressure Release Button, Tempered Glass Lid, Rack, Inner Pot, Pressure Cooker Handle, Control Panel, Housing, Inner Lid, Silicone Gasket, Anti-Clog Filter, Measuring Cup, Water-Collection Box, Rice Spoon and Soup Ladle are to be free from manufacturer defects.

All electrical components are warranted for 1 year from the date of purchase, under normal household use, and when operated in accordance with the Manufacturer's written instructions. The Manufacturer will provide the necessary parts and labor to repair any part of the NuWave Nutri-Pot Digital Pressure Cooker at NuWave, LLC. Service Department. After the expiration of the warranty, the cost of the labor and parts will be the responsibility of the owner.

THE WARRANTY DOES NOT COVER

The Limited Warranty is voided if repairs are made by an unauthorized dealer or the serial number data plate is removed or defaced. Normal deterioration of finish due to use or exposure is not covered by this Warranty. This Limited Warranty does not cover failure, damages or inadequate performance due to accident, acts of God (such as lightning), fluctuations in electric power, alterations, abuse, misuse, misapplications, corrosive type atmospheres, improper installation, failure to operate in accordance with the Manufacturer's written instructions, abnormal use or commercial use.

TO OBTAIN SERVICE

The owner shall have the obligation and responsibility to: Pay for all services and parts not covered by the warranty; Prepay the freight to and from Service Department for any part or system returned under this warranty; Carefully package the product using adequate padding material to prevent damage in transit. The original container is ideal for this purpose. Include in the package the owner's name, address, day time telephone number, a detailed description of the problem, and your "RGA number." e-mail help@nuwavenow.com to obtain the RGA (Return Goods Authorization number). Provide the cooking system model & serial number and proof of date of purchase (a copy of the receipt) when making claims under this warranty.

MANUFACTURER'S OBLIGATION

The Manufacturer's obligation under this Limited Warranty is limited to repairing or replacing any part covered by this Limited Warranty which upon examination is found to be defective under normal use. The Limited Warranty is applicable only within the continental United States and only to the original purchaser of the manufacturer's authorized channels of distribution. THE LIMITED WARRANTY MAY NOT BE ALTERED, VARIED OR EXTENDED EXCEPT BY A WRITTEN INSTRUMENT EXECUTED BY THE MANUFACTURER. THE REMEDY OF REPAIR OR REPLACEMENT AS PROVIDED UNDER THIS LIMITED WARRANTY IS EXCLUSIVE. IN NO EVENT SHALL THE MANUFACTURER BE LIABLE FOR ANY CONSEQUENTIAL OR INCIDENTAL DAMAGES TO ANY PERSON, WHETHER OR NOT OCCASIONED BY NEGLIGENCE OF THE MANUFACTURER, INCLUDING WITHOUT LIMITATION, DAMAGES FOR LOSS OF USE, COSTS OF SUBSTITUTION, PROPERTY DAMAGE, OR OTHER MONEY LOSS.

Some states do not allow the exclusion or limitation of incidental or consequential damages, so the above limitation exclusions may not apply. This Limited Warranty gives specific legal rights, and there may also be other rights which vary from state to state. EXCEPT AS OTHERWISE EXPRESSLY PROVIDED ABOVE, THE MANUFACTURER MAKES NO WARRANTIES EXPRESSED OR IMPLIED ARISING BY LAW OR OTHERWISE, INCLUDING WITHOUT LIMITATION, THE IMPLIED WARRANTIES OF MERCHANTABILITY AND FITNESS FOR A PARTICULAR PURPOSE TO ANY OTHER PERSON. READ YOUR OWNER'S MANUAL. IF YOU STILL HAVE ANY QUESTIONS ABOUT OPERATION OR WARRANTY OF THE PRODUCT, PLEASE CONTACT NUWAVE, LLC.

READ YOUR OWNER'S MANUAL: If you still have any questions about operation or warranty of the product, please contact **NuWave, LLC at: e-mail help@nuwavenow.com.**

Pressure Cooking Notes

PRESSURE COOKING

Tip:

The NuWave Nutri-Pot Digital Pressure Cooker will beep to indicate that the cooking time is complete.

Preheating: While the unit reaches the appropriate temperature for the function selected, the display will show “PH” indicating that it is preheating. Once the unit reaches the appropriate pressure, it will shift from preheating to the selected preset cooking time. Once pressure has built inside the Pressure Cooker, the PH display will change to P, followed by the amount of time it will remain under pressure.

Pressure: The function selected will determine the amount of pressure time. In this example, the display will show “P0:10” (pressure time). The colon or “:” will flash to indicate that the Pressure Cooker is under pressure and the timer is counting down.

Auto Warm Feature: When pressure cooking is complete, the Pressure Cooker will automatically switch to the warm function. This allows the pressure to naturally release while your food remains warm. The times for the presets are listed on page 15.

What is quick release? To quickly release the pressure, simply press the Quick Release Button. This will rapidly release the steam, and when the pressure indicator is down this allows you to safely open your Pressure Cooker. By releasing the steam this way you can quickly open The Pressure Cooker without cooling off the pot and stopping the cooking process.



What is natural release? To naturally release the pressure, simply wait for the pressure indicator to go down, allowing the Pressure Cooker to naturally release steam as it slowly cools. This allows you to finish the cooking process as the Pressure Cooker gradually releases steam. The natural release method takes up to 15 minutes. If the pressure remains in the Pressure Cooker, simply press the Quick Release Button to release any remaining pressure.



NuWave Oven® Pro Plus



**NuWave Nutri-Pot® 6Q
Digital Pressure Cooker**



**NuWave Brio®
Digital Air Fryer**

**Nutri-Master®
Slow Juicer**



**Duralon® Healthy Ceramic
Non-Stick Cookware**



**NuWave PIC® Gold
Precision Induction Cooktop**



**Flavor-Lockers®
with Vacuum-Seal Technology**

nuwave®

— LIVE WELL FOR LESS —

www.NuWaveNow.com

FOR HOUSEHOLD USE ONLY

Model: 33101, 33112, 120V, 60Hz, 1000 Watts

For patent information please go to: www.nuwarennow.com/legal/patent

Designed & Developed in USA by:

NuWave, LLC

1755 N. Butterfield Rd.

Libertyville, IL 60048, U.S.A.

Customer Service:

help@nuwarennow.com • www.NuWaveNow.com

Made in China

©2017 NuWave, LLC • All Rights Reserved.

Item No. BM 33100 A

Rev. 02